

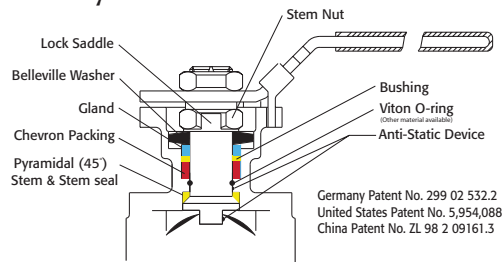

Triac Series 22 Ball Valves feature a high quality investment cast body and end. They are available in sizes from 1/4" to 3". Superior leak protection is accomplished by using our patented "Pyramidal" stem seal system shown in the graphic below. This advanced system protects against wear and leakage experienced by other ordinary ball valves.



VALVE SIZE	VALVE Cv
1/4"	7
3/8"	8
1/2"	15
3/4"	40
1"	70
1-1/4"	110
1-1/2"	250
2"	350
2-1/2"	600
3"	900



Easy to Automate!

See automated data sheets for pre-sized assemblies



Pneumatic



Electric



Series 22
DIRECT MOUNT
2-Piece Design

- Sizes 1/4"– 3"
- Full Port Valve
- Direct Actuator Mount
- 800/1000 psi WOG
- NACE MR-0175
- 2-piece High Cycle Design
- 316 SS Body, Ball and Stem
- Pyramidal Stem Packing System
- Blowout Proof Stem
- ISO 5211 Mounting
- Locking Handle Standard

STANDARDS

- ANSI B16.34, B16.25, B1.20.1
- API 6D
- ISO 5211
- MSS SP25, SP55
- BS 5351, 21

HOW TO ORDER
MANUAL VALVES

SAMPLE PART #

22-TH-0200-XXX

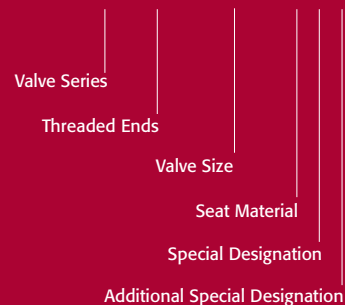

See part number matrix for itemized options



Triac Division
11363 Deerfield Rd.
Cincinnati, Ohio 45242
PHONE (513) 247-5465
FAX (513) 247-5462
e-mail: sales@a-tcontrols.com
www.a-tcontrols.com

Series 22

Direct Mount High Cycle Full Port Ball Valve

Pressure vs. Temperature Chart

For RTFE Seats

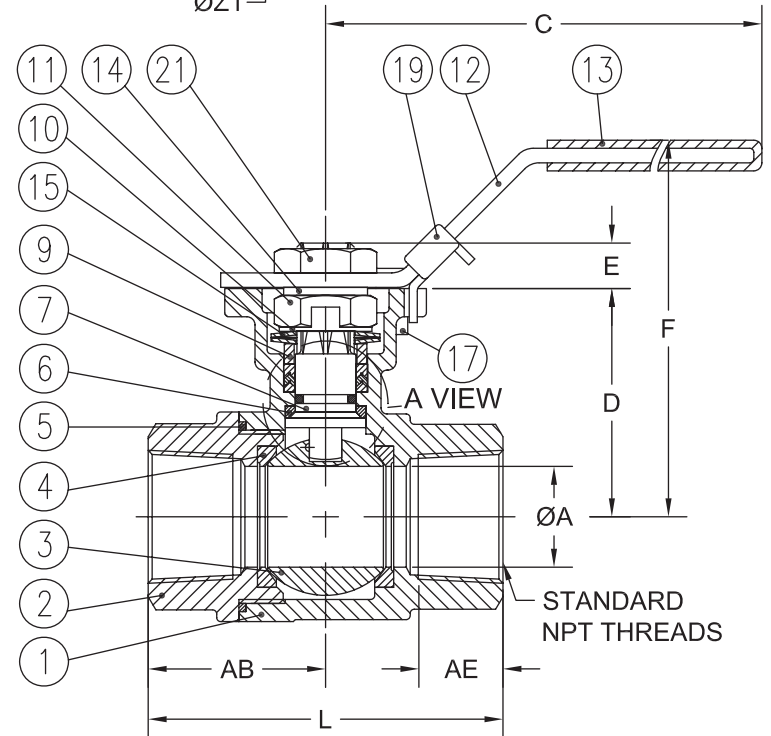
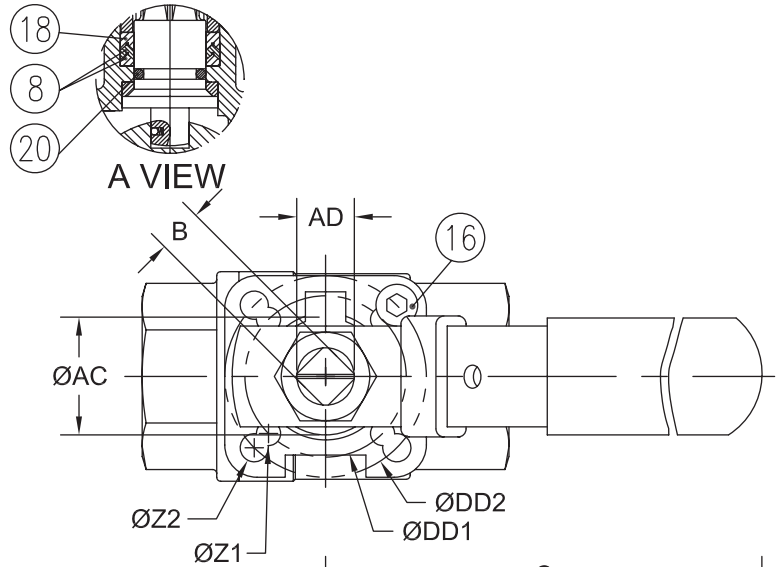
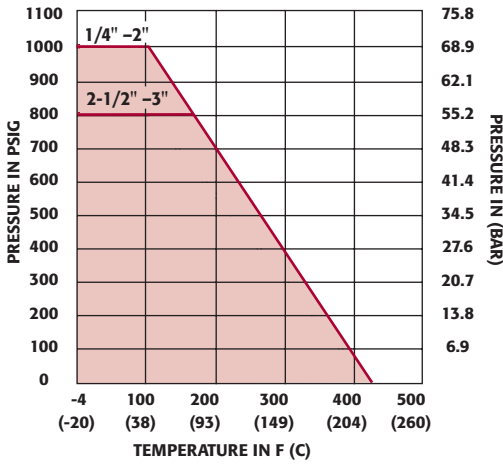

MATERIALS LIST

NO.	PART NAME	QTY.	MATERIAL
1	Body	1	CF8M
2	End Cap	1	CF8M
3	Ball	1	SS316
4	Seat	2	RTFE
5	Joint Gasket	1	PTFE
6	Thrust Washer	1	RTFE
7	Stem	1	SS316
8	Gland Packing	*	PTFE
9	Gland Bush	1	SS304
10	Stop Washer	1	SS304
11	Stem Nut	1	SS304
12	Handle	1	SS304
13	Handle Sleeve	1	Vinyl
14	Stem Washer	1	SS304
15	Belleville Washer	2	SS301
16	Stop Pin	1	SS304
17	Pin Nut	1	SS304
18	Gland Packing	1	RTFE
19	Locking Device	1	SS304
20	O-Ring	1	Viton®
21	Handle Nut	1	SS304

Break Away Torques RTFE Seats

SIZE	IN-LBS.
1/4"	62
3/8"	62
1/2"	62
3/4"	71
1"	124
1-1/4"	159
1-1/2"	230
2"	319
2-1/2"	487
3"	770

For other seat material, consult factory

* For 1/4" - 1/2", 1 pc.
For 3/4" - 2", 2 pcs.
For 2-1/2" - 3", 3 pcs.

DIMENSION (IN)

SIZE	A	B	C	D	E	F	L	Z1	Z2	AB	AC	AD	AE	DD1	DD2	(LBS)	ISO5211
1/4"	0.45	0.354	5.88	1.53	0.26	2.99	2.56	0.26	0.28	1.28	0.92	0.43	0.55	1.417	1.969	1.23	F03/F04/F05
3/8"	0.49	0.354	6.12	1.52	0.26	2.99	2.56	0.26	0.28	1.28	0.92	0.43	0.53	1.471	1.969	1.23	F03/F04/F05
1/2"	0.59	0.354	5.83	1.60	0.26	3.05	2.56	0.26	0.28	1.28	0.92	0.43	0.53	1.417	1.969	1.23	F03/F04/F05
3/4"	0.79	0.354	5.88	1.82	0.28	3.23	2.94	0.26	0.28	1.47	0.91	0.43	0.61	1.417	1.969	1.32	F03/F04/F05
1"	0.98	0.433	6.77	2.24	0.43	3.74	3.46	0.26	0.28	1.73	1.26	0.56	0.72	1.654	1.969	2.40	F04/F05
1-1/4"	1.26	0.433	6.77	2.40	0.43	3.92	4.02	0.24	0.27	2.01	1.26	0.56	0.81	1.654	1.969	3.31	F04/F05
1-1/2"	1.50	0.551	8.51	3.06	0.55	4.00	4.33	0.29	0.35	2.17	1.53	0.75	0.76	1.969	2.756	5.62	F05/F07
2"	1.97	0.551	8.51	3.35	0.56	5.16	4.92	0.29	0.35	2.46	1.53	0.75	0.89	1.969	2.756	7.93	F05/F07
2-1/2"	2.56	0.669	10.53	4.31	0.67	6.18	6.32	0.39	0.48	3.16	2.07	0.88	1.09	2.756	4.016	16.38	F07/F10
3"	3.15	0.669	11.88	4.63	0.71	6.80	7.01	0.39	0.48	3.51	2.08	0.88	1.19	2.756	4.016	22.81	F07/F10

Viton® is a registered trademark of E.I. DuPont de Nemours.
A-T Controls, Inc. reserves the right to change product designs and technical/dimensional specifications without notice.

1106-22M

A-T Controls, Inc.

Triac Division
11363 Deerfield Rd.
Cincinnati, Ohio 45242

PHONE (513) 247-5465
FAX (513) 247-5462
e-mail: sales@a-controls.com
www.a-controls.com